

LUXEON 3014

Hot color targeted industry standard package for uniformed light

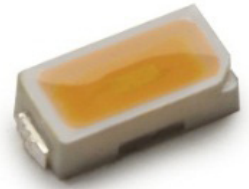

Introduction

The LUXEON 3014 low-power device is an industry standard compatible package for ease of installation into existing 3014 sockets and stays consistent with dimensions of 3.0mm x 1.4mm x 0.7mm. The LUXEON 3014 is an ideal choice when uniformity and reduction in spottiness is necessary for indoor designs.

Features

- Industry standard package
- 1/9 micro binning
- Hot targeted
- Rectangular package design

Benefits

- Widely compatible
- Ease of color consistency
- Leads to better color accuracy
- Increases uniformity

Key Applications

- Indoor Area Lighting
 - Wall Grazer
 - Cove Lighting
 - Troffer
 - TLEDs
- Lamps
- Specialty
 - Freezer Display

Table of Contents

General Information	2
Product Nomenclature	2
Average Lumen Maintenance Characteristics.....	2
Environmental Compliance	2
Product Selection	3
Electrical Characteristics	3
Absolute Maximum Ratings	4
JEDEC Moisture Sensitivity.....	4
Reflow Soldering Characteristics.....	5
Mechanical Dimensions and Package Information	6
Mechanical Dimensions	6
Solder Pad Design	7
Package Information	7
Characteristic Curves	8
Typical Forward Current Characteristics	9
Typical Light Output Characteristics.....	10
Typical Radiation Patterns	11
Emitter Packaging.....	12
Product Binning and Labeling	14
Luminous Flux Bins	14
Forward Voltage Bins.....	15
Color Bin Structure	16

General Information

Product Nomenclature

LUXEON 3014 is tested and binned at $T_j = 25^\circ\text{C}$ with a drive current of 60 mA DC.

The part number designation is explained as follows:

L 13 0 - A A B B C D 1 4 0 0 0 0 1

Where:

- A — designates CCT (2700K = 27)
- B — designates CRI (70, 80 and 90)
- C — attributes (0)
- D — designates voltage

For example, a white LUXEON 3014 4000K/80CRI emitter has the following part number:

L 13 0 - 4 0 8 0 0 0 1 4 0 0 0 0 1

Average Lumen Maintenance Characteristics

The LUXEON 3014 is being tested in accordance with LM-80 standards. Please contact your Philips Lumiled's TSM or sales person for more detailed information.

Environmental Compliance

Philips Lumileds is committed to providing environmentally friendly products to the solid-state lighting market. LUXEON 3014 is compliant to the European Union directives on the restriction of hazardous substances in electronic equipment, namely the RoHS and REACH directives. Philips Lumileds will not intentionally add the following restricted material to the LUXEON 3014 L130-XX8001400001: lead, mercury, cadmium, hexavalent chromium, polybrominated biphenyls (PBB) or polybrominated diphenyl ethers (PBDE).

Product Selection

Product Selection Guide for LUXEON 3014 Low-Power LEDs

Junction Temperature = 25°C

Table 1.

Typical Performance Characteristics at 30 mA & 60 mA with a Junction Temperature = 25°C								
Nominal CCT	Part Number	Minimum CRI ^[1]	Minimum Luminous Flux (lm) @ 60 mA	Typical Luminous Flux (lm)		Typical Forward Voltage (V _f)	Typical Efficacy (lm/W)	
				30 mA	60 mA	60 mA	30 mA	60 mA
2700K	L130-2780001400001	80	18	10	21	3.1	127	113
3000K	L130-3080001400001	80	19	11	21	3.1	129	113
3500K	L130-3580001400001	80	20	11	21	3.1	129	113
4000K	L130-4080001400001	80	21	12	23	3.1	140	124
5000K	L130-5080001400001	80	21	12	23	3.1	140	124
5700K	L130-5780001400001	80	22	13	24	3.1	146	129
6500K	L130-6580001400001	80	22	13	24	3.1	146	129

Notes for Table 1:

1. Philips Lumileds maintains a tolerance of ± 7.5% on luminous flux, ± 2 on CRI measurements.
2. Binned at 25°C.
3. Color targeted at 85°C.
4. Forward voltage test tolerance : ±0.1 volts.

Electrical Characteristics

Junction Temperature = 25°C, Test Current @ 60 mA

Table 2.

Part Number	Forward Voltage V _f (V)			Typical Temperature Coefficient of Forward Voltage Between 25°C and 85°C $\Delta V_F / \Delta T_J$ (mV/°C)	Typical Thermal Resistance Junction to Solder Pad R ^θ _{J-C}
	Minimum	Typical	Maximum		
L130-2780001400001	2.8	3.1	3.3	-2.0 to -4.0	47
L130-3080001400001					
L130-3580001400001					
L130-4080001400001					
L130-5080001400001					
L130-6580001400001					

Absolute Maximum Ratings

Table 3.

Parameter	Maximum Performance
DC Forward Current	100 mA ^[2]
Peak Pulsed Forward Current	120 mA ^[3]
ESD Sensitivity	Human Body Model (HBM) Class 2 ANSI/ESDA/JEDEC JS-001-2012
Operating Case Temperature @ 60 mA	-40°C - 105°C
Soldering Temperature	JEDEC 020D 260°C
Storage Temperature	-40°C - 100°C
LED Junction Temperature ^[1]	115°C
Allowable Reflow Cycles	3
Reverse Voltage	-5V

Notes for Table 3:

1. Ripple current with a frequency of 50-150 Hz is allowed as long as the average of the current waveform is below 100 mA and the maximum of the current waveform is lower than 120 mA.
2. At 10% duty cycle and pulse width 10ms.
3. LUXEON 3014 are not designed to be driven in reverse bias.
4. At a maximum reverse current of 10 μ A.

JEDEC Moisture Sensitivity

Table 4.

Level	Floor Life		Soak Requirements	
	Time	Conditions	Standard	
			Time	Conditions
3	168 hours	30°C / 60% RH (Relative Humidity)	192 Hrs. + 5 / -0 Hrs.	30°C / 60% RH

Reflow Soldering Characteristics

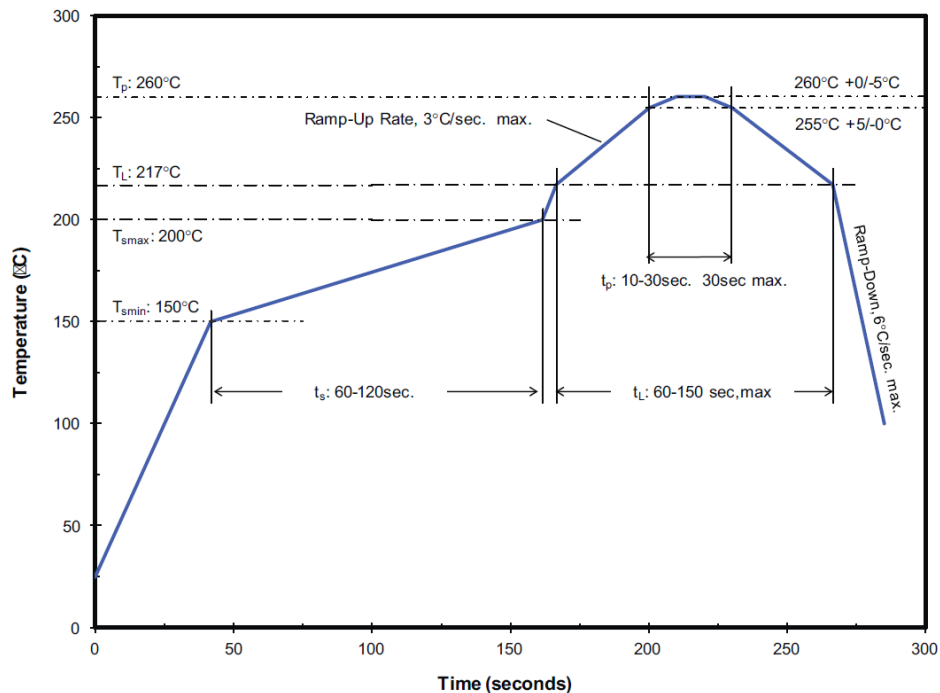

Figure 1. Temperature Profile for Table 5.

Table 5. Reflow Profile in Accordance with J-Std-020D

Profile Feature	Lead Free Assembly
Preheat/Soak:	
Temperature Min (T_{smin})	150°C
Temperature Max (T_{smax})	200°C
Maximum Time (t_s) from T_{smin} to T_{smax}	120 seconds
Ramp-Up Rate (T_L to T_p)	3°C / second
Liquidous Temperature (T_L)	217°C
Maximum Time (t_L) Maintained T_L	150 seconds
Maximum Peak Package Body Temperature (T_p)	260°C
Time (t_p) Within 5°C of the Specified Temperature (T_C)	10 - 30 seconds
Maximum Ramp-Down Rate (T_p to T_L)	6°C / second
Maximum Time 25°C to Peak Temperature	8 minutes

Note for Table 5:

- All temperatures refer to the application Printed Circuit Board (PCB), measured on the surface adjacent to the package body.

Mechanical Dimensions and Package Information

Mechanical Dimensions

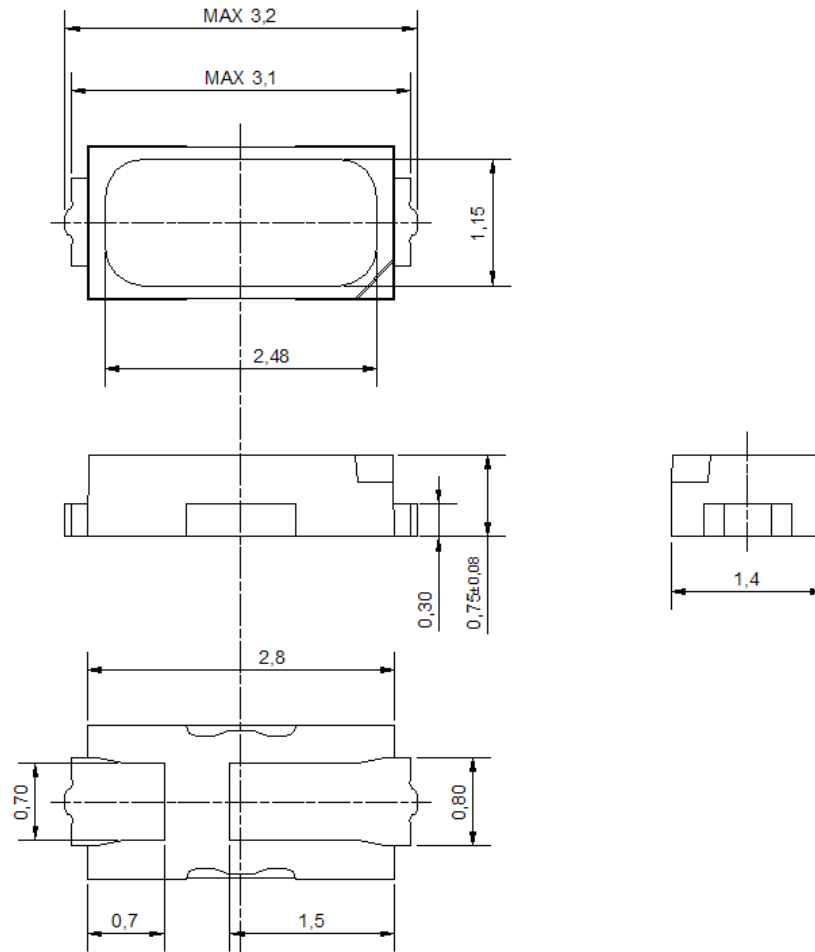

Figure 2.

Notes for Figure 2:

1. All dimensions are in millimeters.
2. Tolerance $\pm 0.10\text{mm}$.

Solder Pad Design

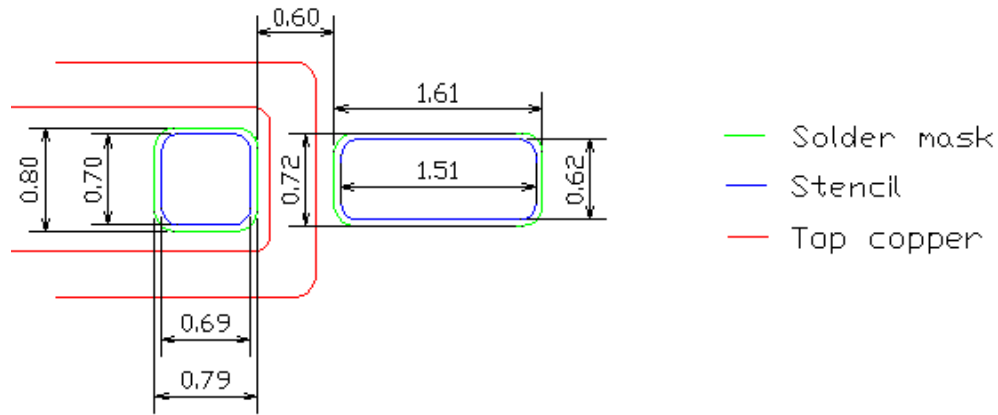

Figure 3.

Notes for Figure 3:

1. The drawing above shows the recommend solder pad layout on the Printed Circuit Board (PCB).
2. Application Brief AB208 provides extensive details for this layout. In addition, the .drawing files are available at www.philipslumileds.com and www.philipslumileds.cn.com.

Package Information

Table 6. Package Information for L130-xx800014-00001

Material/Component	Specification
Lead Frame Base	Copper Alloy
Package Body	High Temperature Thermal Plastic
Encapsulate	Silicone Resin, with Phosphor
Weight	0.08gram

Characteristic Curves

Relative Spectral Distribution vs. Wavelength

Junction Temperature = 25°C; Test Current = 60 mA

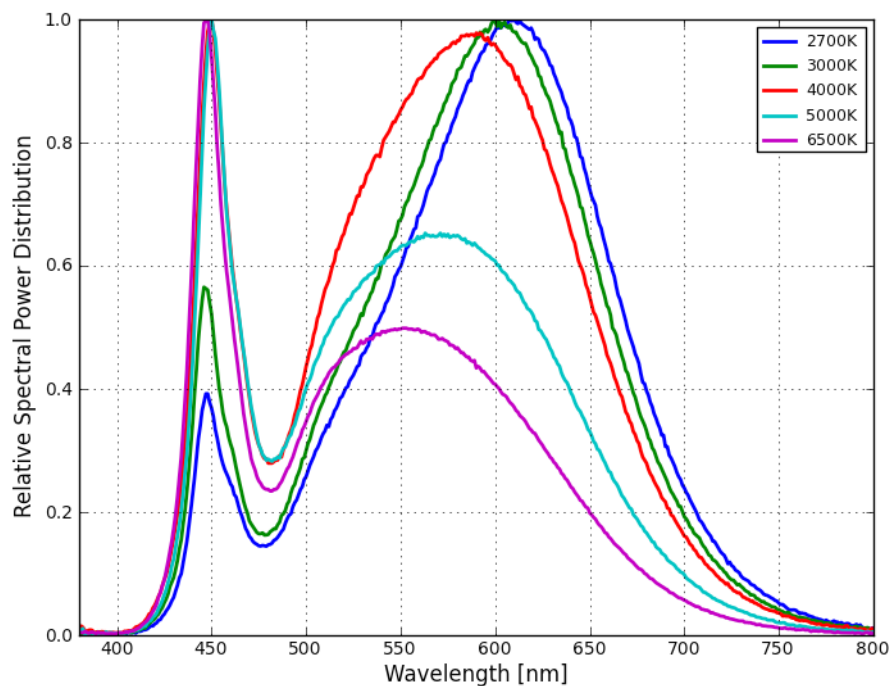

Figure 4. Color spectrum, L130-xx80-0014-00001.

Relative Light Output Characteristics over Junction Temperature

Test Current = 60 mA

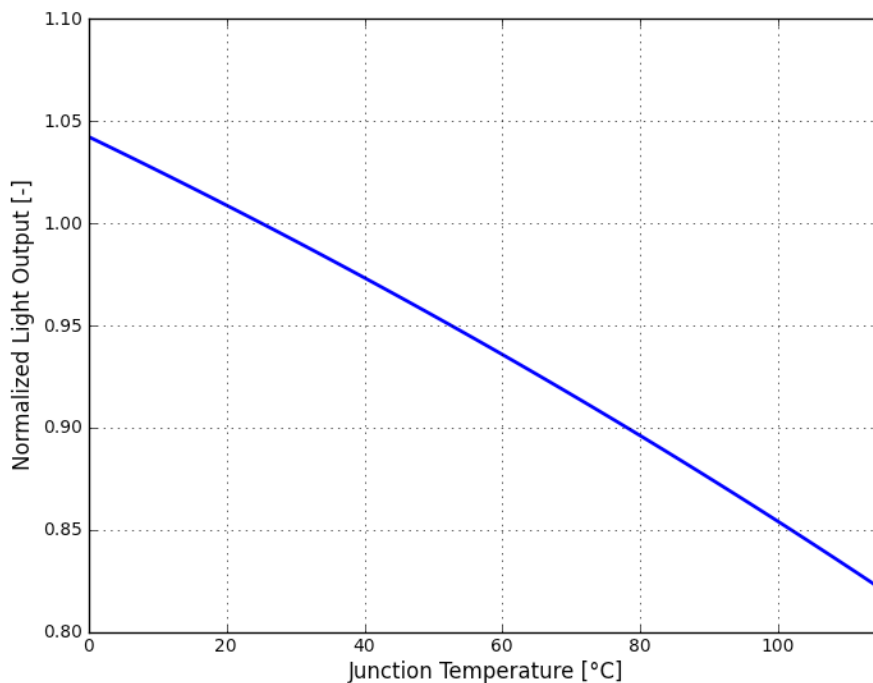

Figure 5. Relative light output vs. junction temperature, L130-xx8001400001.

Typical Forward Current Characteristics

Forward Current vs. Forward Voltage for L130-xx80001400001
Junction Temperature = 25°C

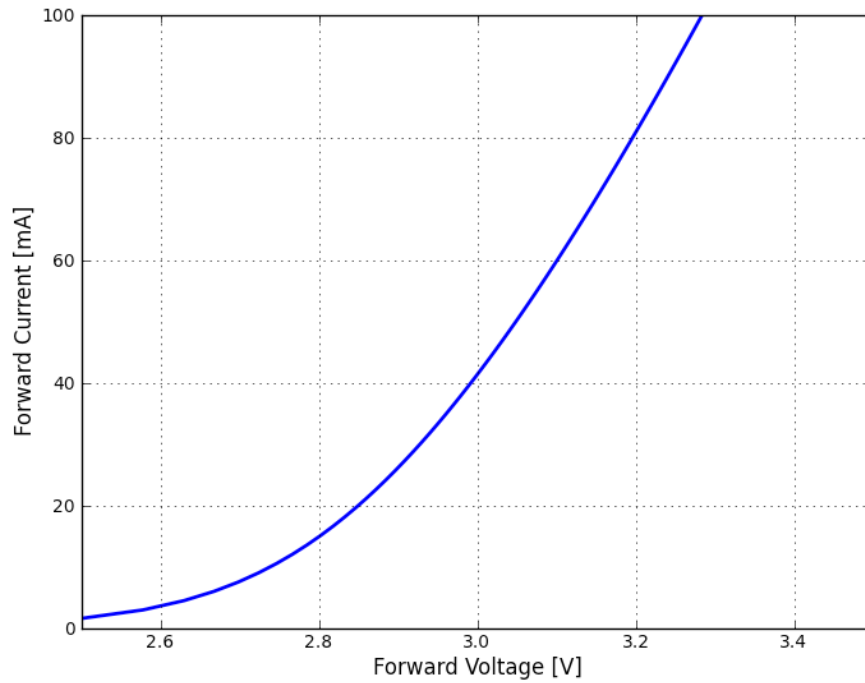

Figure 6. Typical forward current vs. forward voltage, L130-xx8001400001.

Typical Light Output Characteristics

Relative Light Output vs. Forward Current
Junction Temperature = 25°C

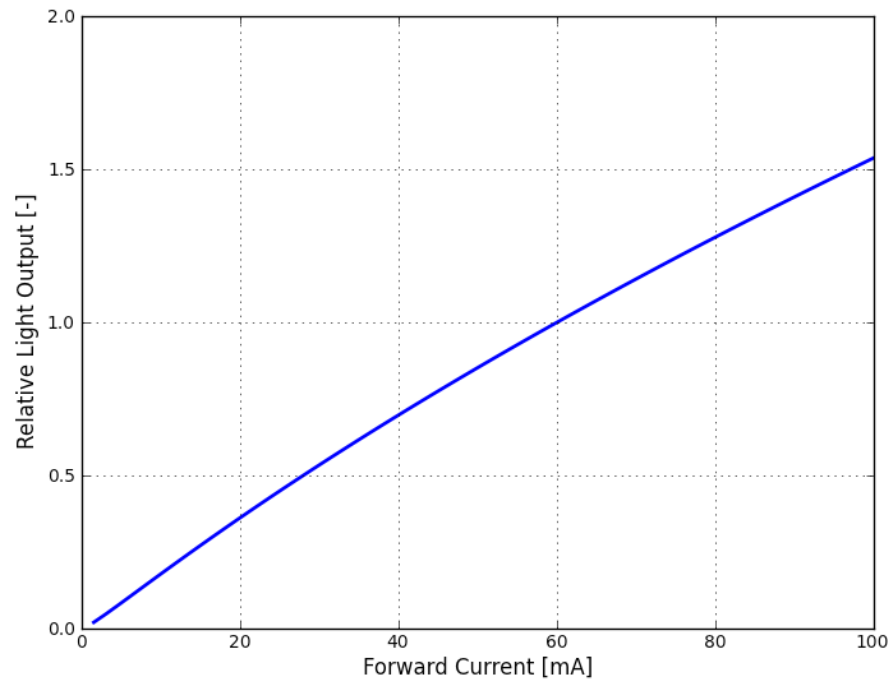

Figure 7. Typical forward current vs. forward voltage, L130-xx8001400001.

Typical Radiation Patterns

Radiation Pattern in Cartesian Coordinate System Junction Temperature = 25°C

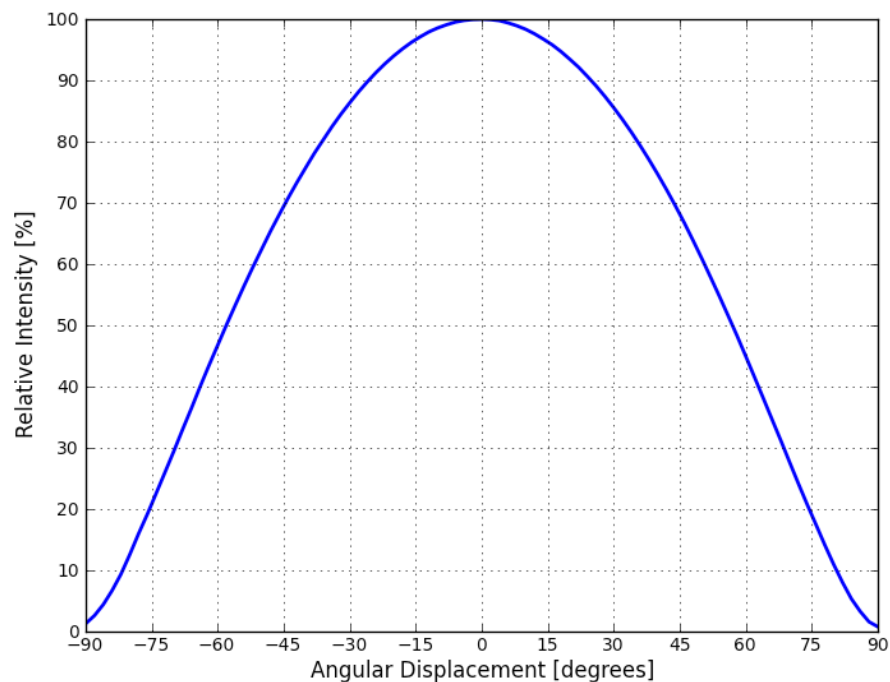

Figure 8. Typical spatial radiation pattern, L130-xx8001400001.

Radiation Pattern in Polar Coordinate System Junction Temperature = 25°C

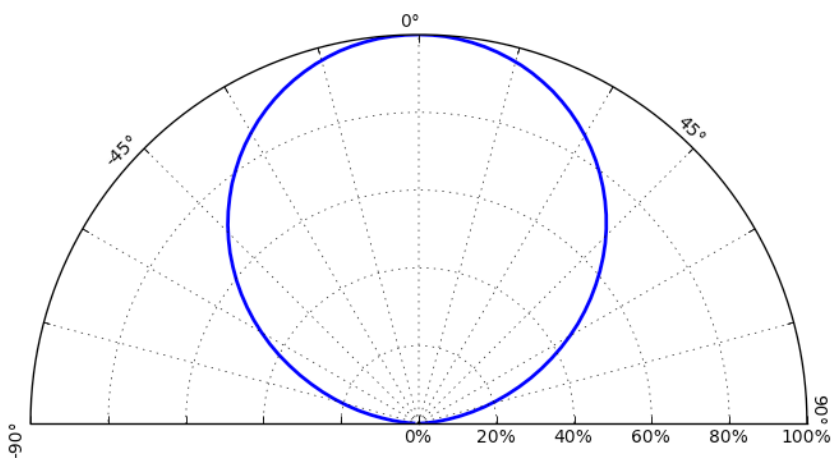

Figure 9. Typical polar radiation pattern, L130-xx8001400001.

Emitter Packaging

Emitter Pocket Tape Packaging

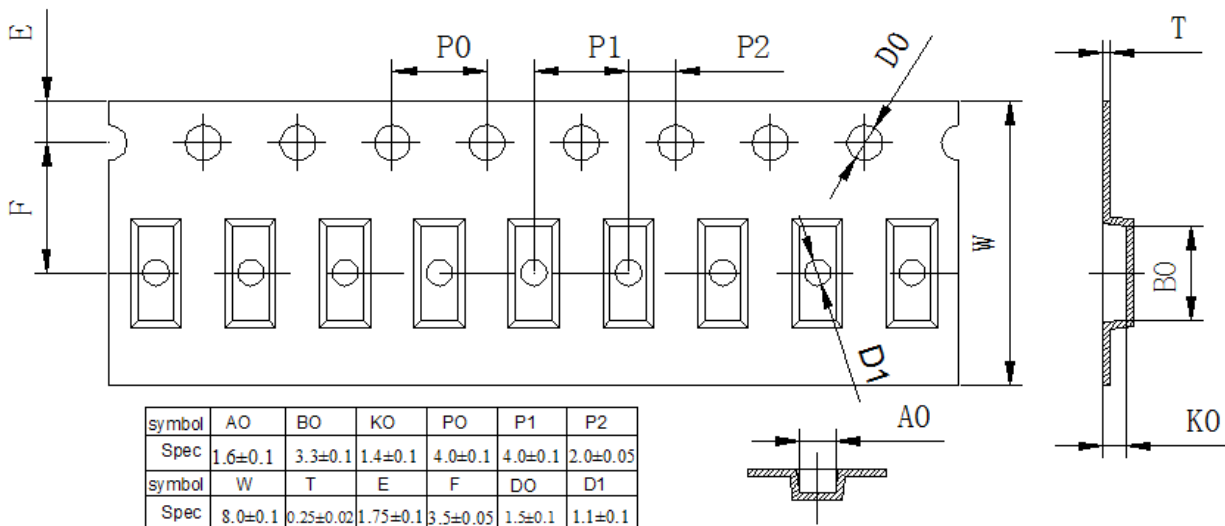
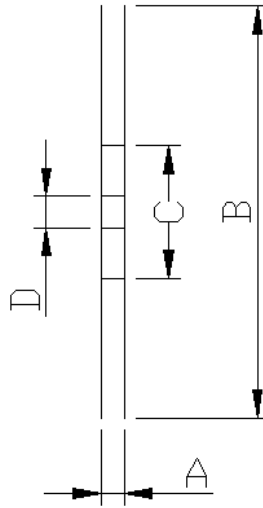
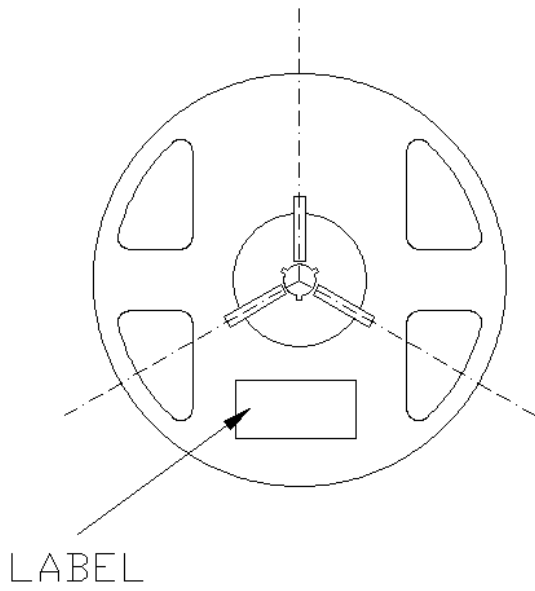

Figure 10.

Notes for Figure 10:

1. All dimensions are in millimeters.
2. Empty component pockets sealed with top cover tape.
3. The maximum number of consecutive missing LEDs is two.

Emitter Reel Packaging



A	$8.0 \pm 0.1 \text{mm}$
B	$178 \pm 1 \text{mm}$
C	$60 \pm 1 \text{mm}$
D	$13.0 \pm 0.5 \text{mm}$

Figure 11.

Notes for Figure 11:

1. All dimensions are in millimeters.
2. Empty component pockets sealed with top cover tape.
3. 7 inch reel-3000 pieces per reel.
4. Minimum packing quantity is 500 pieces.
5. The maximum number of consecutive missing LEDs is two.
6. In accordance with EIA-481-1-B specification.

Product Binning and Labeling

Purpose of Product Binning

In the manufacturing of semiconductor products, there is a variation of performance around the average values given in the technical data sheets. For this reason, Philips Lumileds bins the LED components for luminous flux, color and forward voltage (V_f).

Decoding Product Bin Labeling

LUXEON mid-power emitters are labeled using a four digit alphanumeric code (CAT code) depicting the bin values for emitters packaged on a single reel. All emitters packaged within a reel are of the same 3-variable bin combination. Using these codes, it is possible to determine optimum mixing and matching of products for consistency in a given application.

Reels of 2700K, 3000K, 3500K, 4000K, 5000K, 5700K, 6500K emitters are labeled with a four digit alphanumeric CAT code following the format below.

ABCD

Where:

A = Flux bin (L etc.)

B & C = Color bin (For example 5J, 5E, 5D, 5K)

D = V_f bin

Luminous Flux Bins

Table 7 and Table 8 list the standard photometric luminous flux bins for LUXEON mid-power emitters (tested and binned at 60 mA). Although several bins are outlined, product availability in a particular bin varies by production run and by product performance. Not all bins are available in all colors. Please contact your Philips Lumileds representative for the L130-XX80014-00001 & L130-XX8001400001 flux bins.

Table 7.

Bin Code	Minimum Photometric Flux (lm)	Maximum Photometric Flux (lm)
A	8.5	10
B	10	11.5
C	11.5	13
D	13	15
E	15	17
F	17	19
G	19	21
H	21	24
J	24	28
K	28	32

Note for Table 7:

1. Tested and binned at 25°C, $I_f=60$ mA.
2. Tester tolerance: $\pm 7.5\%$.

Forward Voltage Bins

Table 8. V_f Bin for L130-xx80014-00001

Bin Code	Minimum Forward Voltage (V)	Maximum Forward Voltage (V)
T	2.8	2.9
V	2.9	3.0
W	3.0	3.1
X	3.1	3.2
Y	3.2	3.3

Note for Table 8:

1. Tested and binned at 25°C, $I_f=60$ mA.
2. Forward voltage test tolerance: ± 0.1 volts.

Color Bin Structure

The LUXEON 3014 is hot color targeted so that at 85°C, the color is within ANSI.

Typical bin structure at 85°C.

In application conditions, the LED temperature rises and at 85°C the typical color bins will be as shown.

Note: Bin *N will represent the entire ANSI bin for that corresponding CCT. For example, bin 7N will represent the entire bin for 3000K ANSI.

L130-2780-0014-00001 Color Bin Structure

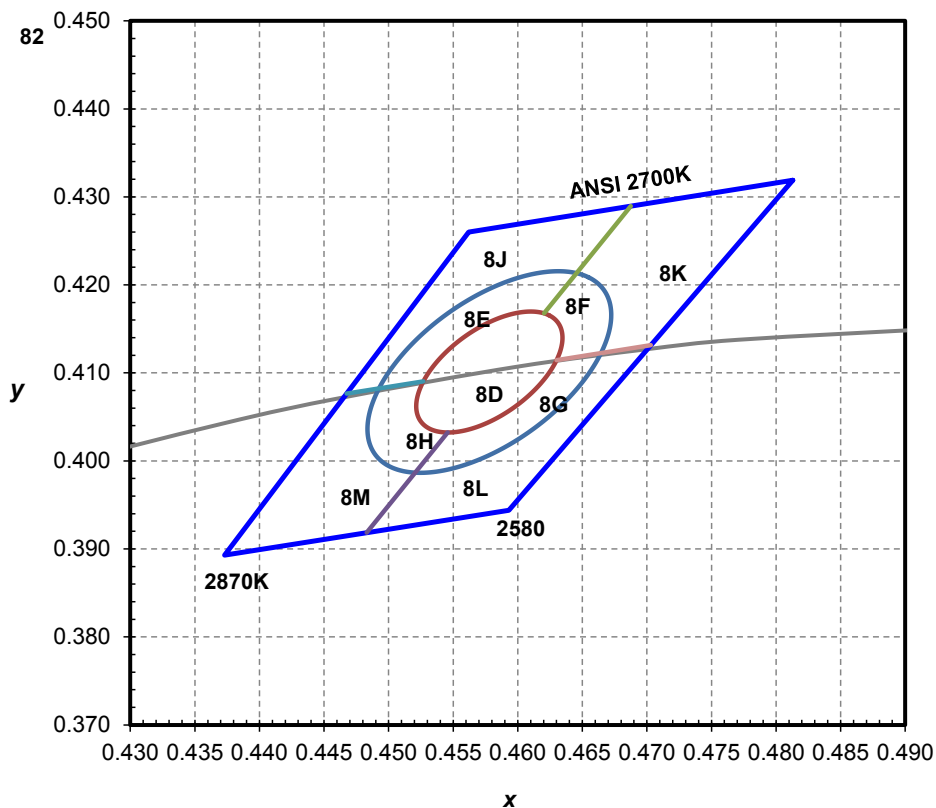

Figure 12. 2700K 1/9th color bin structure.

Table 9.

Nominal ANSI CCT	Color Space	Target Center Point (cx, cy)	Major Axis, a	Minor Axis, b	Ellipse Rotation Angle
2700K	Single 3-step MacAdam ellipse	(0.4578, 0.4101)	0.00810	0.00420	53.70°
2700K	Single 5-step MacAdam ellipse	(0.4578, 0.4101)	0.01350	0.00700	53.70°

L130-3080-0014-00001 Color Bin Structure

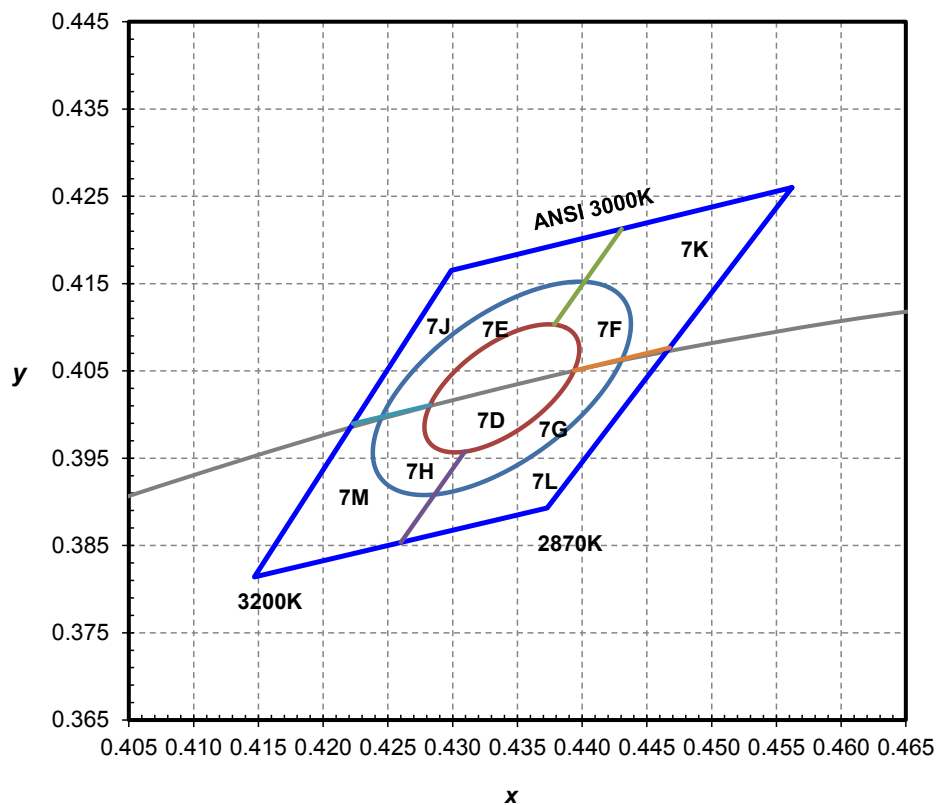

Figure 13. 3000K 1/9th color bin structure.

Table 10.

Nominal ANSI CCT	Color Space	Target Center Point (cx, cy)	Major Axis, a	Minor Axis, b	Ellipse Rotation Angle
3000K	Single 3-step MacAdam ellipse	(0.4338, 0.403)	0.00834	0.00408	53.22°
3000K	Single 5-step MacAdam ellipse	(0.4338, 0.403)	0.01390	0.00680	53.22°

L130-3580-0014-00001 Color Bin Structure

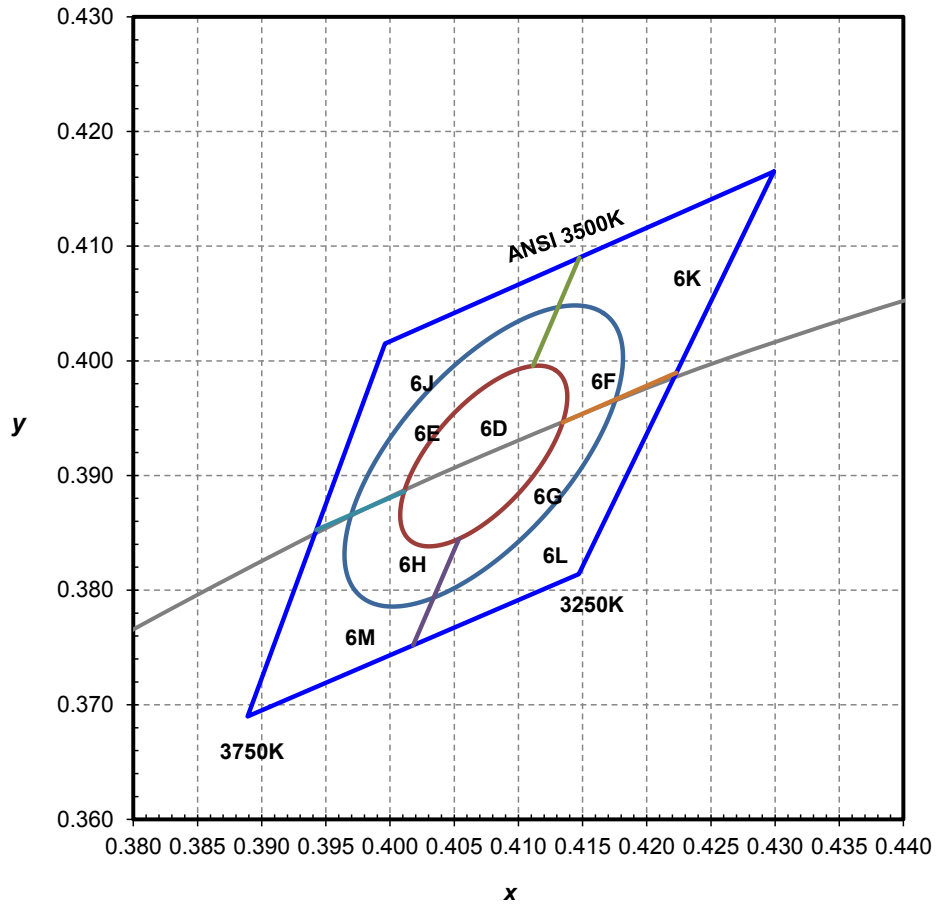

Figure 14. 3500K 1/9th color bin structure.

Table 11.

Nominal ANSI CCT	Color Space	Target Center Point (cx, cy)	Major Axis, a	Minor Axis, b	Ellipse Rotation Angle
3500K	Single 3-step MacAdam ellipse	(0.4073, 0.3917)	0.00927	0.00414	54.00°
3500K	Single 5-step MacAdam ellipse	(0.4073, 0.3917)	0.01545	0.00690	54.00°

L130-4080-0014-00001 Color Bin Structure

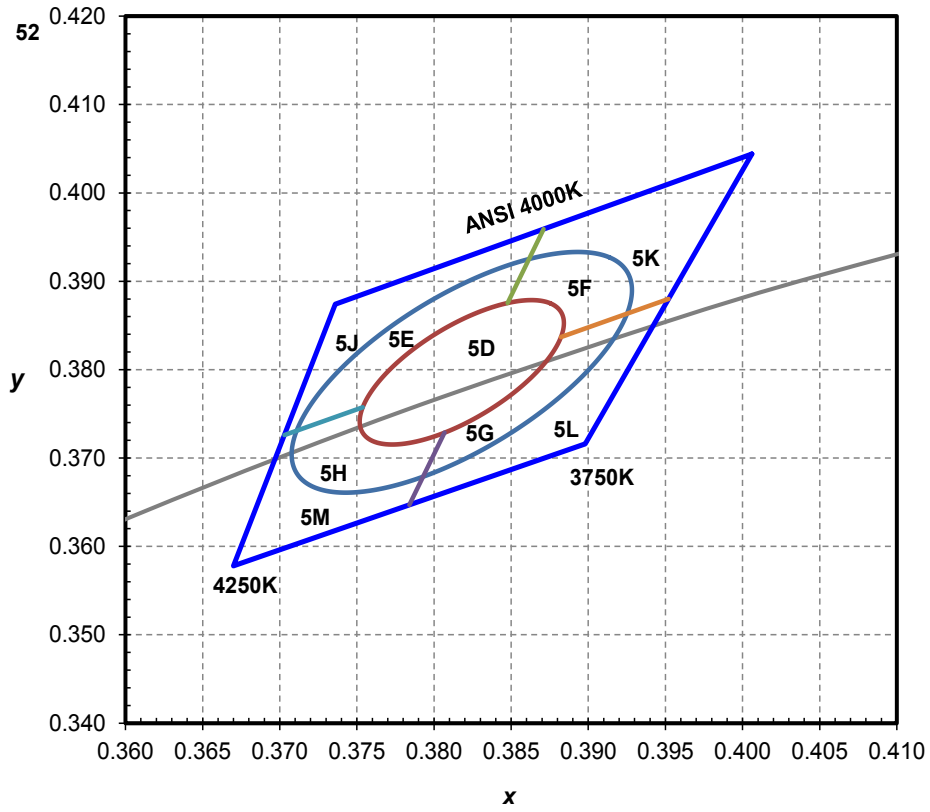

Figure 15. 4000K 1/9th color bin structure.

Table 12.

Nominal ANSI CCT	Color Space	Target Center Point (cx, cy)	Major Axis, a	Minor Axis, b	Ellipse Rotation Angle
4000K	Single 3-step MacAdam ellipse	(0.3818, 0.3797)	0.00939	0.00402	53.72°
4000K	Single 5-step MacAdam ellipse	(0.3818, 0.3797)	0.01565	0.00670	53.72°

L130-5080-0014-00001 Color Bin Structure

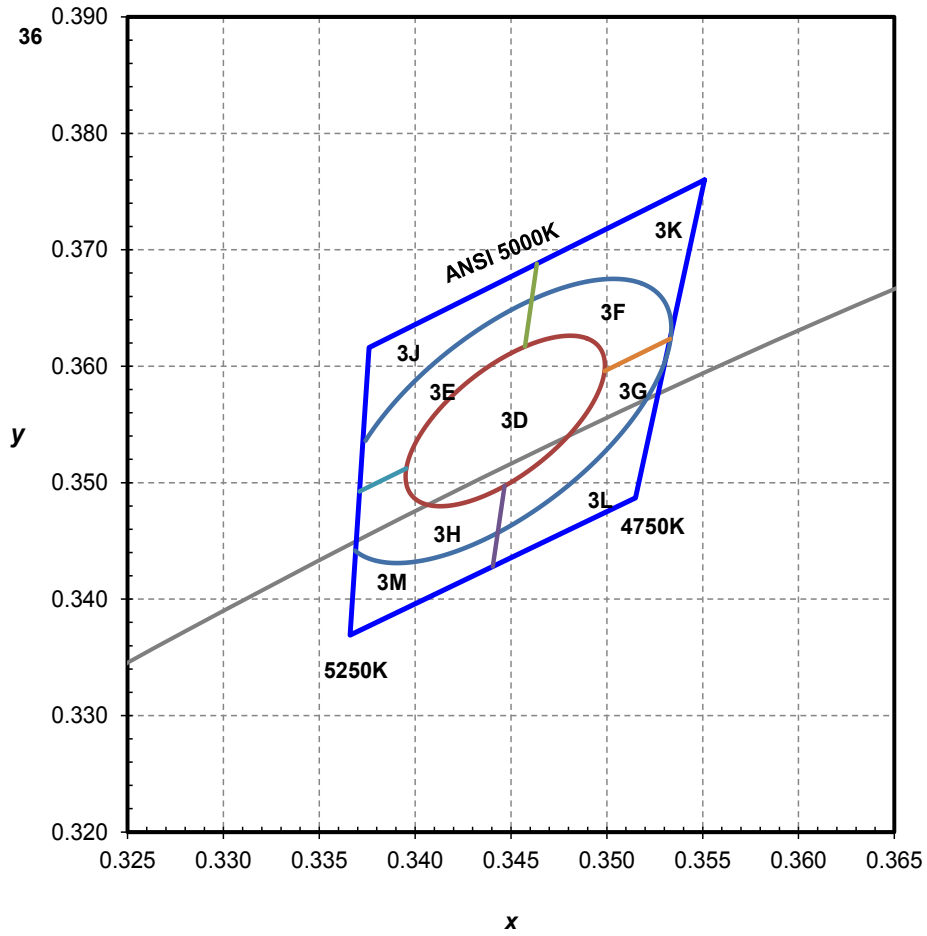

Figure 16. 5000K 1/9th color bin structure.

Table 13.

Nominal ANSI CCT	Color Space	Target Center Point (cx, cy)	Major Axis, a	Minor Axis, b	Ellipse Rotation Angle
5000K	Single 3-step MacAdam ellipse	(0.3447, 0.3553)	0.00822	0.00354	59.62°
5000K	Single 5-step MacAdam ellipse	(0.3447, 0.3553)	0.01370	0.00590	59.62°

L130-5780-0014-00001 Color Bin Structure

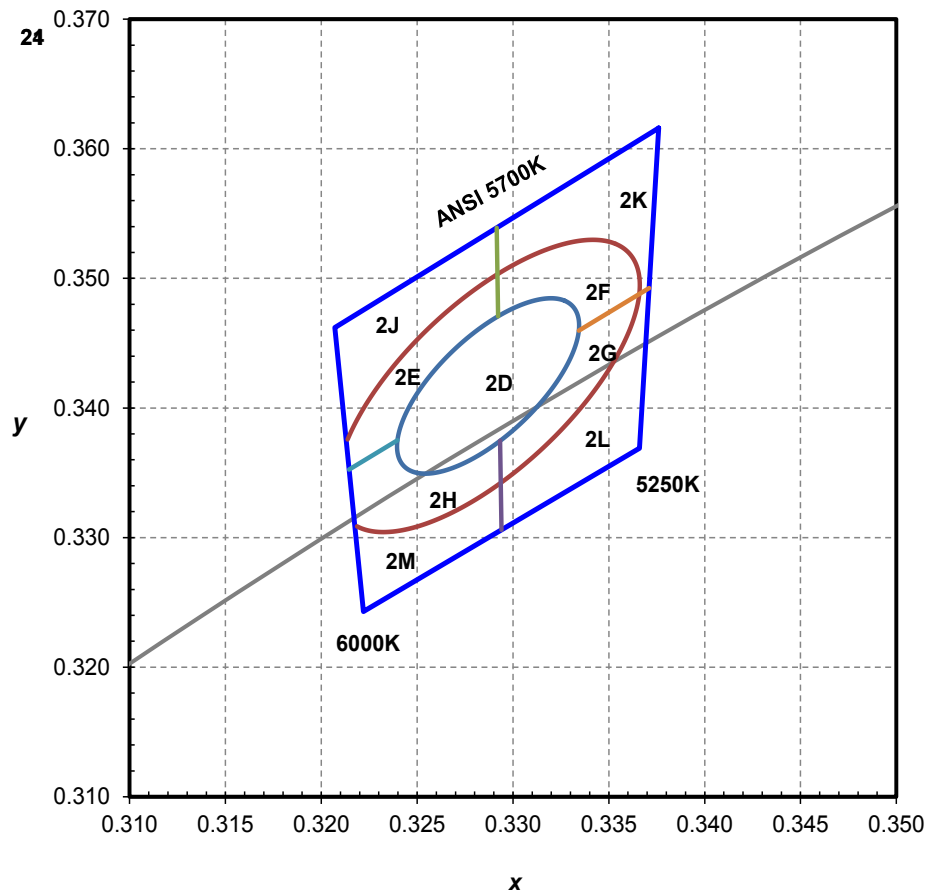

Figure 17. 5700K 1/9th color bin structure.

Table 14.

Nominal ANSI CCT	Color Space	Target Center Point (cx, cy)	Major Axis, a	Minor Axis, b	Ellipse Rotation Angle
5700K	Single 3-step MacAdam ellipse	(0.3287, 0.3417)	0.00746	0.00320	59.09°
5700K	Single 5-step MacAdam ellipse	(0.3287, 0.3417)	0.01243	0.00533	59.09°

L130-6580-0014-00001 Color Bin Structure

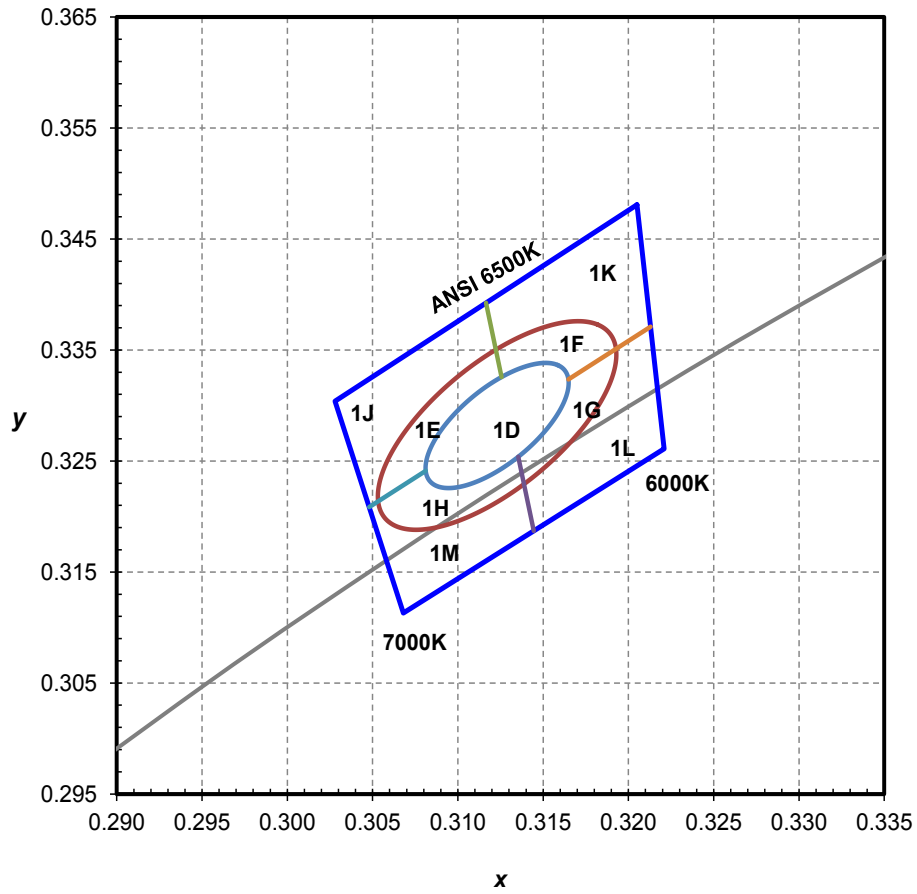

Figure 18. 6500K 1/9th color bin structure.

Table 15.

Nominal ANSI CCT	Color Space	Target Center Point (cx, cy)	Major Axis, a	Minor Axis, b	Ellipse Rotation Angle
6500K	Single 3-step MacAdam ellipse	(0.3123, 0.3282)	0.00669	0.00285	58.57°
6500K	Single 5-step MacAdam ellipse	(0.3123, 0.3282)	0.01115	0.00475	58.57°

Who We Are

Philips Lumileds focuses on one goal: Creating the world's highest performing LEDs. The company pioneered the use of solid-state lighting in breakthrough products such as the first LED backlit TV, the first LED flash in camera phones, and the first LED daytime running lights for cars. Today we offer the most comprehensive portfolio of high quality LEDs and uncompromising service.

Philips Lumileds brings LED's qualities of energy efficiency, digital control and long life to spotlights, downlights, high bay and low bay lighting, indoor area lighting, architectural and specialty lighting as well as retrofit lamps. Our products are engineered for optimal light quality and unprecedented efficacy at the lowest overall cost. By offering LEDs in chip, packaged and module form, we deliver supply chain flexibility to the inventors of next generation illumination.

Philips Lumileds understands that solid state lighting is not just about energy efficiency. It is about elegant design. Reinventing form. Engineering new materials. Pioneering markets and simplifying the supply chain. It's about a shared vision. Learn more about our comprehensive portfolio of LEDs at www.philipslumileds.com.

Philips Lumileds Lighting Company shall not be liable for any kind of loss of data or any other damages, direct, indirect or consequential, resulting from the use of the provided information and data. Although Philips Lumileds Lighting Company has attempted to provide the most accurate information and data, the materials and services information and data are provided "as is" and Philips Lumileds Lighting Company neither warranties, nor guarantees the contents and correctness of the provided information and data. Philips Lumileds Lighting Company reserves the right to make changes without notice. You as user agree to this disclaimer and user agreement with the download or use of the provided materials, information and data.



©2014 Philips Lumileds Lighting Company. All rights reserved.
LUXEON is a registered trademark of the Philips Lumileds Lighting Company in the United States and other countries.

www.philipslumileds.com
www.philipslumileds.cn.com